

BLANK PANEL BP5H-M

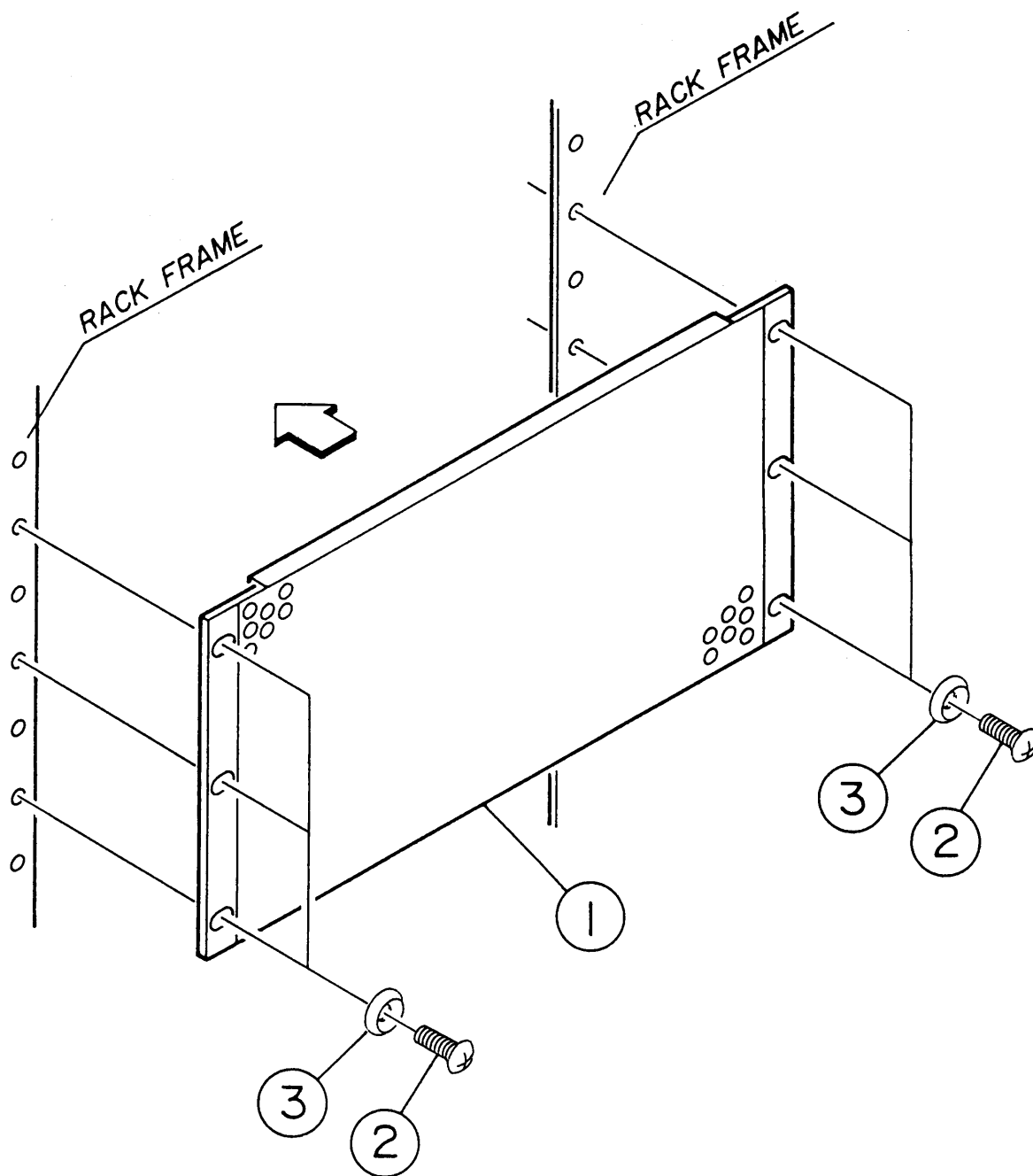

NO.	DESCRIPTION	QTY	CODE NO.
1	BLANK PANEL BP 5H-M	1	A4-923-501
2	SCREW,OVAL HEAD M5x0.8x14 B-NI	6	M2-002-091
3	FINISHING WASHER 5CW	6	M5-003-031